

版本 REV.	日期 DATE	ECN NO.	变更内容 DESCRIPTION	制图 DRAWN

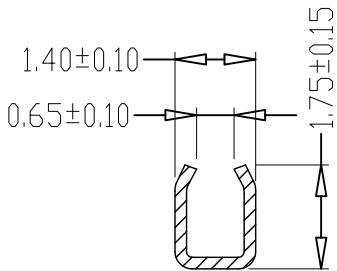

SEC:C-C

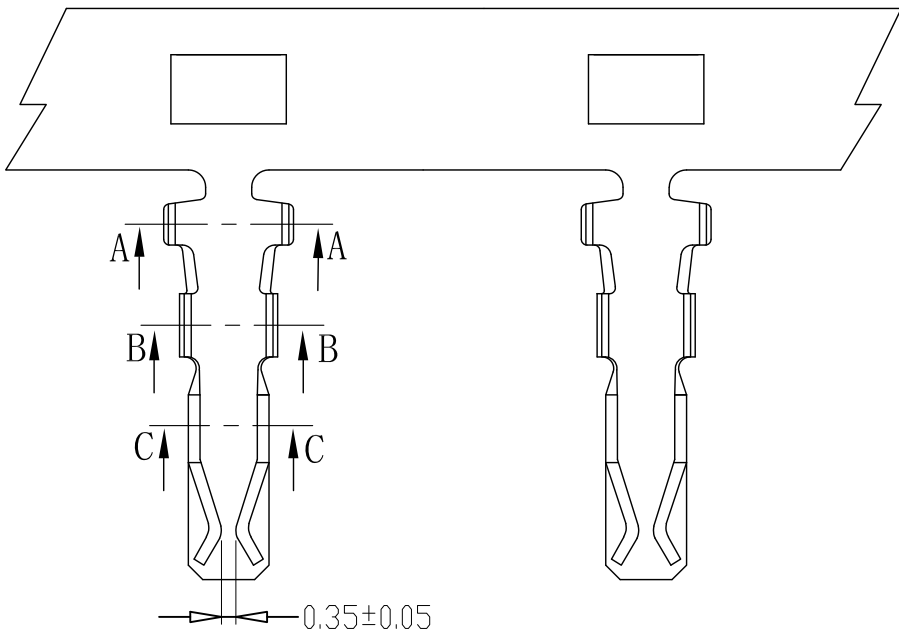
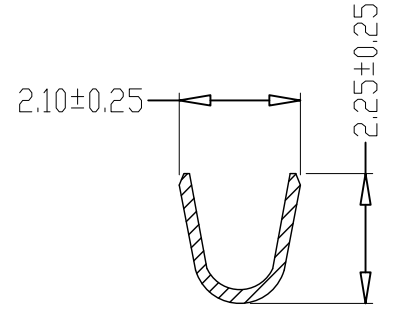
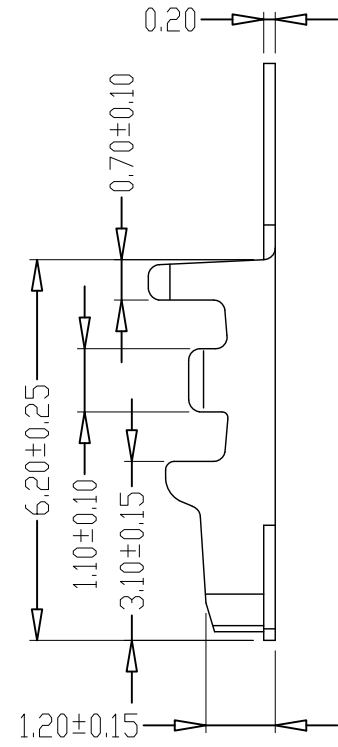

SEC:A-A

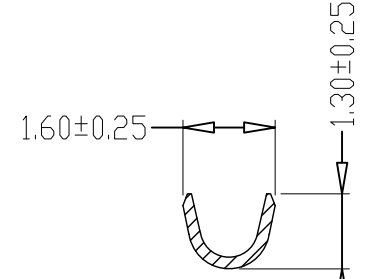

SEC:B-B

SPECIFICATIONS

- 1、Current Rating: 3A AC, DC
- 2、Voltage Rating: 250V AC, DC
- 3、Temperatuer Range: -25°C~+85°C
- 4、Contact Resistance: 20mΩ Max
- 5、Insulation Resistance: 1000MΩ Min
- 6、Withstanding Voltang: 800V AC/minute
- 7、Material:Phosphoric bronze Tin-plated
- 8、Applicable Wire Sizes:AWG#22~28#

GENERAL TOLERANCE		制图 Mapping	张迎春 2022、09、10	料号 PART NO.	A20017-T	版本 REV.	A
X.±0.25	X.*±2°	审核 Audit	钱岳生 2022、09、10	品名 TITLE	DF11端子	页次 SHEET	1/1
.X±0.20	.X*±1°	核准 Approved	张名 2022、09、11	客户料号 CUTM. NO.			
.XX±0.15	.XX*±0.5°	单位 Units	MM	比例 SCALE	1:1		
.XXX±0.10	.XXX*±0.5°			乐清市宏一电子有限公司 YueQing HongYi Electronics Co., Ltd			

版本 REV.	日期 DATE	ECN NO.	变更内容 DESCRIPTION	制图 DRAWN

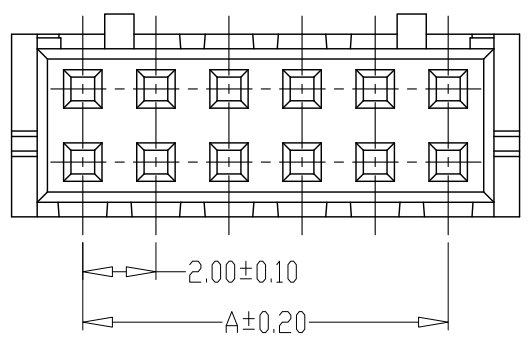
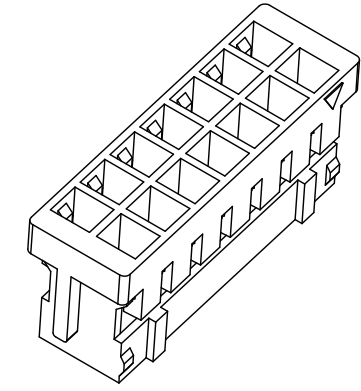
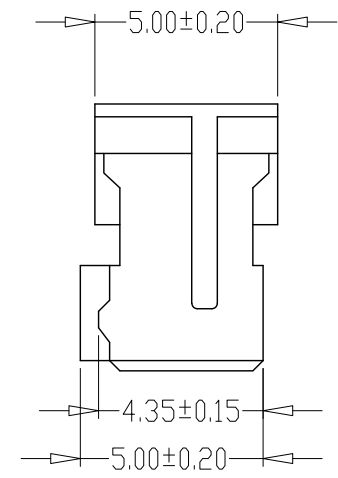
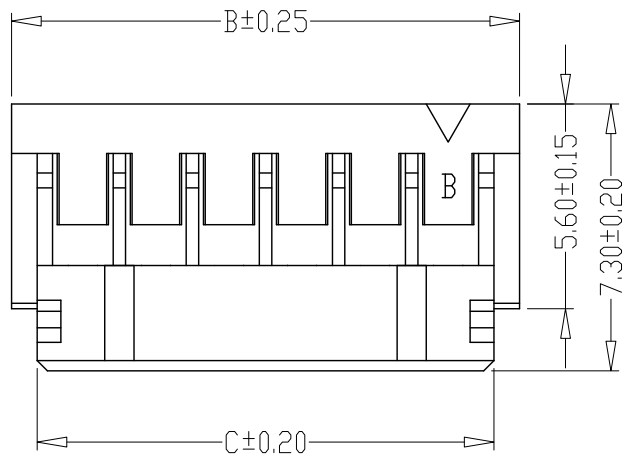

PIN	尺寸 (mm)		
	A	B	C
-2*02Y	2.00	6.10	4.50
-2*03Y	4.00	8.10	6.50
-2*04Y	6.00	10.10	8.50
-2*05Y	8.00	12.10	10.50
-2*06Y	10.00	14.10	12.50
-2*07Y	12.00	16.10	14.50
-2*08Y	14.00	18.10	16.50
-2*09Y	16.00	20.10	18.50
-2*10Y	18.00	22.10	20.50
-2*11Y	20.00	24.10	22.50
-2*12Y	22.00	26.10	24.50
-2*13Y	24.00	28.10	26.50
-2*14Y	26.00	30.10	28.50
-2*15Y	28.00	32.10	30.50
-2*16Y	30.00	34.10	32.50

SPECIFICATIONS

- Current Rating: 3A AC, DC
- Voltage Rating: 250V AC, DC
- Temperatuer Range: -25°C ~ +85°C
- Contact Resistance: 20mΩ Max
- Insulation Resistance: 1000MΩ Min
- Withstanding Voltang: 800V AC/minute
- Material:Housing:PA66, UL94V-0

GENERAL TOLERANCE		制图 Mapping	张迎春 2022、09、10	料号 PART NO.	A20017-2*nY	版本 REV.	A
X±0.25	X*±2°	审核 Audit	钱岳生 2022、09、10	品名 TITLE	DF11孔座	页次 SHEET	1/1
.X±0.20	.X*±1°	核准 Approved	张名 2022、09、11	客户料号 CUTM. NO.			
.XX±0.15	.XX*±0.5°	单位 Units	MM	比例 SCALE	1:1		
.XXX±0.10	.XXX*±0.5°						

**乐清市宏一电子有限公司**  
 Yueqing HongYi Electronics Co., Ltd